

AQUA SPEAKERS

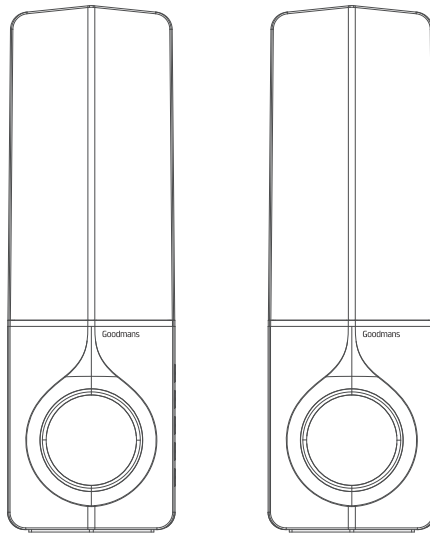

MODEL: 347113

USER MANUAL



Goodmans

1 Welcome



2 Your Aqua Speakers

- 2.1 In The Box
 - 2.2 Side View
 - 2.3 Back View
-

3 Quick Setup

- 3.1 Charging Your Aqua Speakers
 - 3.2 Pairing with a Bluetooth Device
 - 3.3 Playing Your Music
 - 3.4 Using the LINE IN Connection
-

4 Troubleshooting

5 Technical Specifications

6 Customer Support

1 Welcome



Thank you for choosing this Goodmans product. We have been making electrical products for the British people for over 90 years. Each of our products have been carefully designed to be great at what they do and this one is no exception. We hope you enjoy your Aqua Speakers.

2 Your Aqua Speakers

2.1 In The Box

Carefully remove your Aqua Speakers from the packaging. Inside the box you will find:

- Aqua Speakers
- LINE IN Cable
- USB Charging Cable
- Speakers Connecting Cable
- Quick Start Guide
- Instruction Manual
- Safety & Guarantee Leaflet





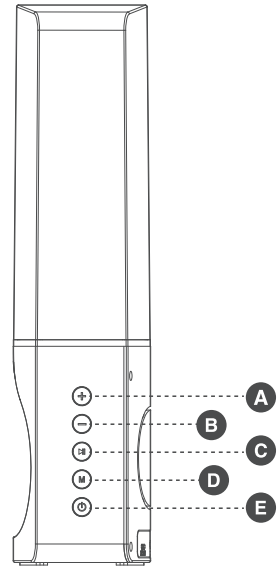

2.2 Side View

- A Increase Volume / Next Track**
Press the button to switch to the next track.
Hold the button to increase the volume.
- B Decrease Volume / Previous Track**
Press the button to switch to the previous track.
Hold the button to decrease the volume.
- C Play / Pause**
Press the button to play or pause the music.
- D Mode**
Press the button to select Bluetooth/
LINE IN function.
- E Power ON / OFF Button**
Press and hold the button for three
seconds to switch the power ON or OFF.



2.3 Back View

- F**  
Pair box stereo connection.
- G** **Micro USB Charging Socket**
Used to charge the battery.
- H** **LINE IN Input**
Used to connect the Aqua Speakers
to devices without Bluetooth.
- I**  
Main box stereo connection.

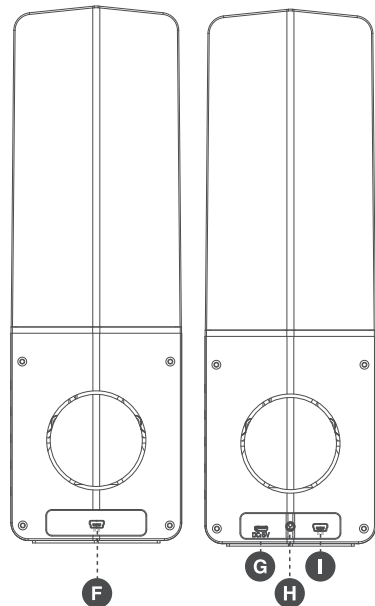

3 Quick Setup



3.1 Charging Your Aqua Speakers

1. Your Aqua Speakers has a built in rechargeable battery so it can be used anywhere indoors, before using it for the first time please fully charge the battery.
2. To charge, connect the USB cable provided to the USB port on your Aqua Speakers.
3. Connect the other end of the USB cable to a USB port on your computer, or a 5V 1A USB wall charger. A wall charger is not included, when your Aqua Speakers is charging the LED indicator will show RED.
4. When the Aqua Speakers is fully charged the RED LED indicator will turn off.
5. When charging is completed, remove the USB cable.

Note: when the battery is getting low, the low battery warning alert will sound, when you hear this, please recharge the battery.

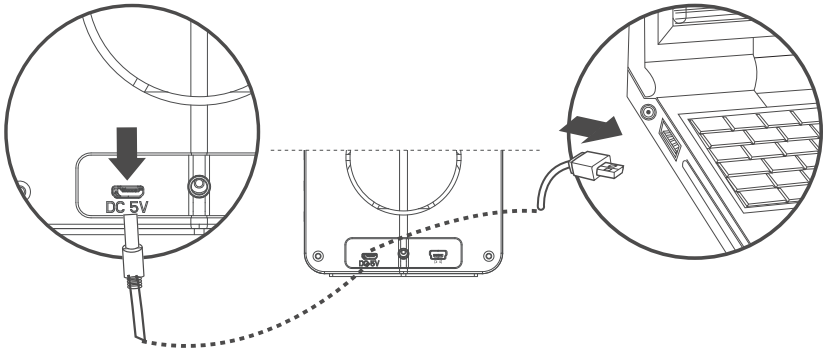



3.2 Pairing with a Bluetooth Device

1. Press and hold the power ON/OFF button to ON; you will hear “Bluetooth mode, pairing”.
2. Using your Bluetooth phone or tablet, turn on Bluetooth and search for Bluetooth devices.
3. Enable Bluetooth on your Smartphone and search for Bluetooth connections, Select “GOODMANS WATER SPKR” from the list of devices, if you are asked for pass code enter “0000”.
4. When successfully paired, you will hear “connected”.
5. Once you have paired the Aqua Speakers with a smartphone, the Aqua Speakers will remember this device and will pair automatically when the device’s Bluetooth is activated and in range, you do not need to re-pair any previously connected devices.
6. The Aqua Speakers will attempt to automatically connect to the last device it was paired with if Bluetooth mode is turned on, if you want to pair it with a new device, please turn off your last Bluetooth device and then use your new device to search and select the pairing name.

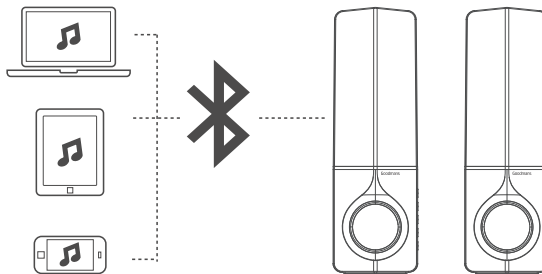

3.3 Playing Your Music

1. Connect the two speakers together with the speaker connecting cable.
2. When your smartphone, phone or tablet is paired to the Aqua Speakers, use your music app to playback your music.

3.4 Using the LINE IN Connection

1. If your device doesn't have Bluetooth, you can use the LINE IN connection.
2. Connect the LINE IN cable to the Aqua Speakers and connect the other end to your device.
3. Select your music on your device and play.

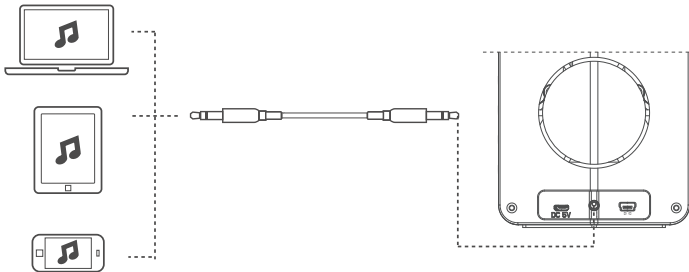

Note: When a Line In cable is connected your Aqua Speakers will disconnect from your Bluetooth device.



Problem	What to do
I can't turn ON my Aqua Speakers.	Make sure that the Aqua Speakers is fully charging. Press the ON/OFF button for 3 seconds to turn it ON.
I can't pair the Aqua Speakers with my Bluetooth device.	Turn on the Aqua Speakers. Make sure that the LINE IN cable is not connected.
I can't hear my music.	Turn the Aqua Speakers ON. Use the volume control on your device to turn the volume up.
My device keeps on disconnecting from the Aqua Speakers.	Make sure the Aqua Speakers is fully charged. If the LINE IN cable is connected, remove it. Make sure that your device is not further than 10 meters away from the Aqua Speakers.

5 Technical Specifications



Model Number	347113
Bluetooth Specification	Bluetooth V 5.0
Operating Distance	10 meters (max.)
Frequency Response	80Hz - 18KHz
Built-in Battery	3.7V / 800mAh
External Power Supply	DC 5V
Speaker Power	2 x 3W
Product Size	9.6 x 7.5 x 30cm

6 Customer Support



This product is intended for use within the UK

This appliance complies with the below listed EU directives

2014/53/EU Radio Equipment Directive

2011/65/EU Restriction of Hazardous Substances Directive

2013/56/EU Waste Batteries & Accumulators

The complete declaration of conformity is available upon request for relevant enquiries.

 **Bluetooth**® is a trademark on a registered trademark of Bluetooth SIG Inc.

Information on Waste Disposal for Consumers of Electrical & Electronic Equipment



This mark on a product and/or accompanying documents indicates that when it is to be disposed of, it must be treated as Waste Electrical & Electronic Equipment (WEEE).

 Any WEEE marked waste products must not be mixed with general household waste, but kept separate for the treatment, recovery and recycling of the materials used.

For proper treatment, recovery and recycling; please take all WEEE marked waste to your Local Authority Civic waste site, where it will be accepted free of charge.

If all consumers dispose of Waste Electrical & Electronic Equipment correctly, they will be helping to save valuable resources and preventing any potential negative effects upon human health and the environment, of any hazardous materials that the waste may contain.



Made in China

Imported by B&M Retail Ltd., Dakota Drive, Liverpool, L24 8RJ, UK

Goodmans