



6 CUBE SHELVING

Item Code: 428457
Assembly Instructions

40min

APPROXIMATE ASSEMBLY TIME

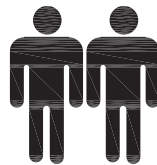

2 PEOPLE ASSEMBLY

FLOOR AREA
1Mx1M

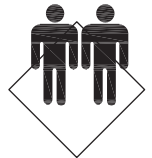

REQUIRED ASSEMBLY SPACE

REQUIRED ASSEMBLY TOOLS

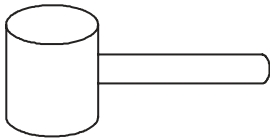

SOFT RUBBER HAMMER(Not Provided)

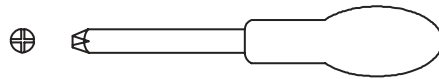

POZI SCREWDRIVER (Not Provided)

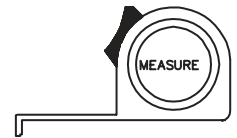

MEASURING TAPE (Not Provided)

ASSEMBLED DIMENSIONS

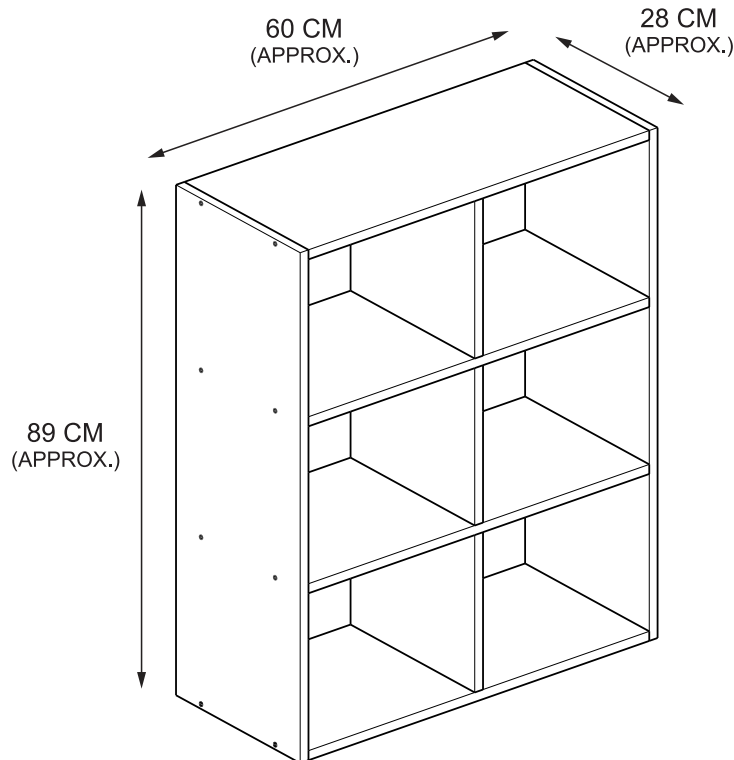

Max.Loading: 24kg (Top: 6kg, Shelf: 3kg each)

SIMPLY 6 CUBE SHELVING

Item Code: 428457

Assembly Instructions

PART LIST

| NO. | PART LIST | QTY | NO. | PART LIST | QTY |
|-----|--------------------|-----|-----|-------------|-----|
| ① | TOP & BOTTOM PANEL | 2 | ④ | BACK PANEL | 3 |
| ② | SIDE PANEL | 2 | ⑤ | SHELF PANEL | 2 |
| ③ | MIDDLE PANEL | 3 | | | |

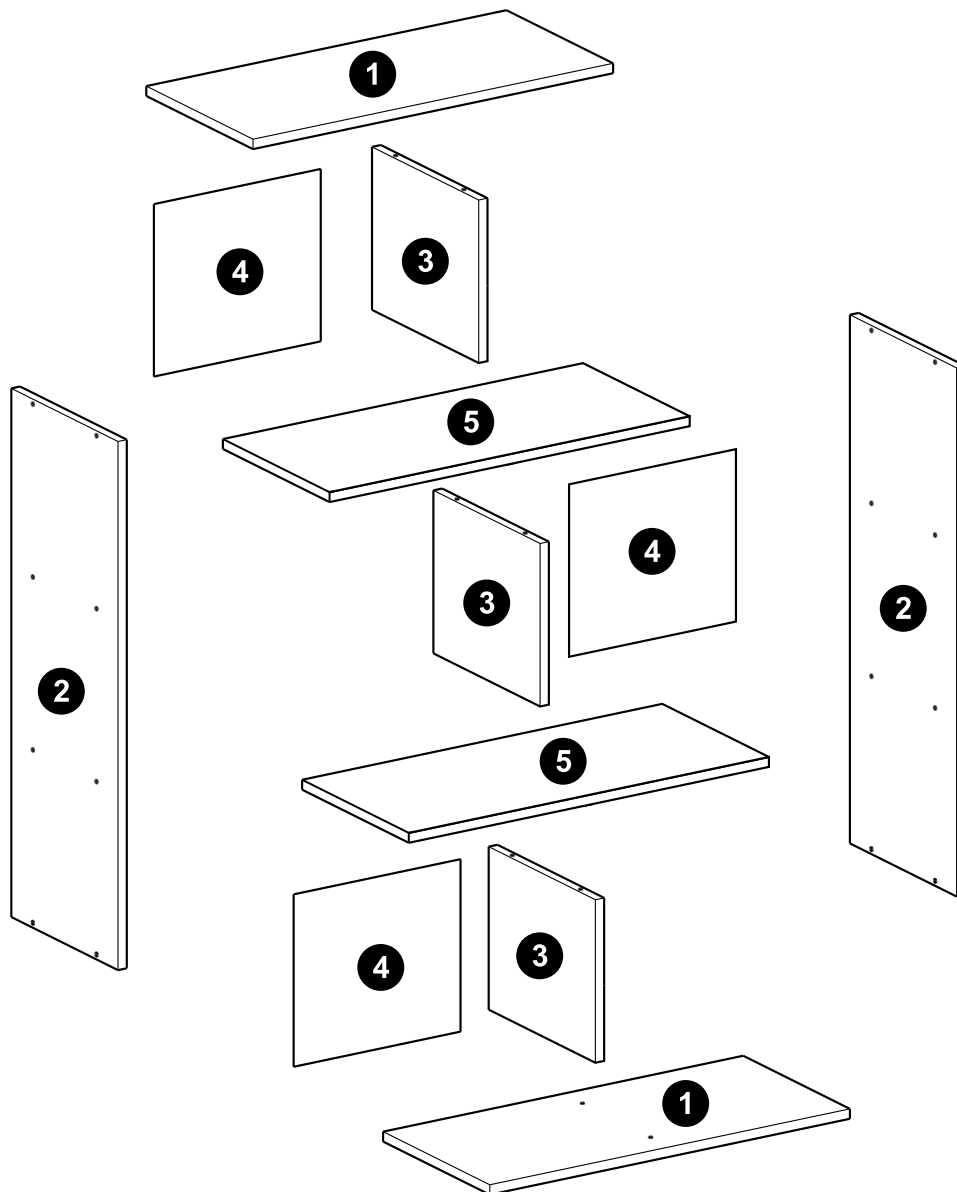







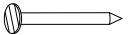
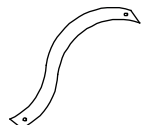

SIMPLY 6 CUBE SHELVING

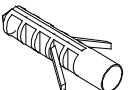
Item Code: 428457

Assembly Instructions

HARDWARE LIST

| | | | | | | | | | |
|---|-----|---|-----|---|----|---|-----|---|----|
| P1 | x18 | P2 | x24 | P3 | x2 | P4 | x4 | P5 | x2 |
|  | |  | |  | |  | |  | |
| M4x35mm | | | | | | | | | |
| SCREW | | NAIL | | WALL STRAP | | SUPPORT PLATE | | WALL PLUG | |
| P6 | x2 | P7 | x4 | P8 | x4 | P9 | x16 | P10 | x4 |
|  | |  | |  | |  | |  | |
| M3.5x12mm | | M5.8x50mm | | M5.8x30mm | | | | | |
| SCREW | | WOOD DOWEL | | WOOD DOWEL | | STICKER | | FLOOR PROTECTOR | |

SIMPLY 6 CUBE SHELVING

Item Code: 428457

Assembly Instructions



Safety Advice and Care Advice

KEEP ALL THE SAFETY ADVICE AND INSTRUCTIONS IN A SAFE PLACE FOR FUTURE REFERENCE!



WARNING! RISK OF LOSS OF LIFE OR ACCIDENT

TO INFANTS AND CHILDREN! Never leave children unsupervised with the packaging materials. Danger of suffocation.

CAUTION! RISK OF INJURY! Make sure that all parts are undamaged and assembled correctly. Improper assembly carries a risk of injury. Damaged parts may affect the safety and function of the product.

- Adult assembly required.
- Power tools are not recommended for the assembly of this product.
- Make sure that this product is stable & used only on a solid & flat surface.
- Do not use this product unless all screws and fixings are firmly secured.
- Do not leave children unsupervised! The product is not a climbing frame or a toy!
- Do not stand, sit or lean on this product
- Do not use this product as a step ladder or as a chopping surface.
- Do not lift or move the product when it is loaded.
- Do not load more than a total of 24kg (Top: 6kg, Shelf: 3kg each) onto the unit, otherwise there is a risk of injury and/or damage to the product
- Distribute weight evenly across the product so that it cannot overturn.
- Do not place hot items such as coffee cups directly on the surface(s) unless adequately thick table mats are used.
- Please periodically check all fittings and re-tighten as necessary.
- For Indoor & Domestic use only.

Care instructions:

- Wipe clean with a dry cloth.
- Do not use scourers, abrasive or chemical solvents.
- Keep away from moisture and direct sunlight.
- Keep away from fire and inflammable objects.
- Store in a dry place.

SIMPLY 6 CUBE SHELVING

Item Code: 428457

Assembly Instructions

NOTE: Supplied wall plugs are only suitable for use in masonry walls.

If you have any doubts about using the correct plug for your wall, please seek professional advice. Failure of the product due to using incorrect fixings is the responsibility of the installer.



IMPORTANT:

When drilling into walls, always check for hidden wires or pipes, etc.



Tips & Tricks

Make sure that the hardware used is suitable for supporting your unit.
Please consult a qualified tradesperson if unsure.

- ✓ If you are unsure, please select a larger screw and wall plug.
- ✓ Ensure that you use the recommended drill bit to match the wall plug and hole size.
- ✓ Take extra care when drilling high walls, ceiling and ceramic tiles. Ensure wall plugs are inserted beyond the thickness of the ceramic tiles to avoid splitting or cracking.
- ✓ Ensure that wall plugs are well fitted and are a tight fit in the drilled hole.

Types Of Walls

Use one of the following types of wall plug (not included) if your walls are made of brick, breeze block, concrete, stone or wood. Screws may be able to be fixed directly to solid wood walls as they will provide a secure anchor point.

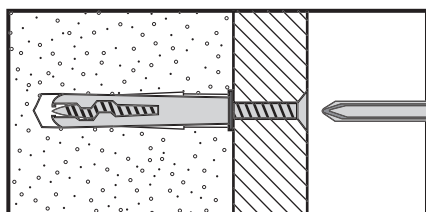

1. General Purpose Wall Plug

Generally, aerated blocks should not be used to support heavy loads, use a specialist fitting in this case. For light loads, general purpose wall plugs can be used.

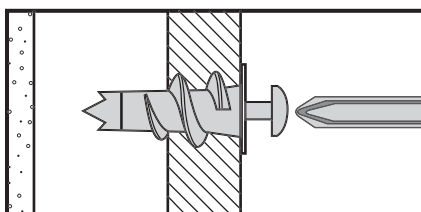

2. Plasterboard Wall Plug

For use when attaching light loads onto plasterboard partitions.

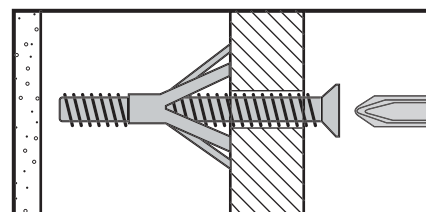

3. Cavity Fixing Wall Plug

For use with plasterboard partitions or hollow wooden doors.

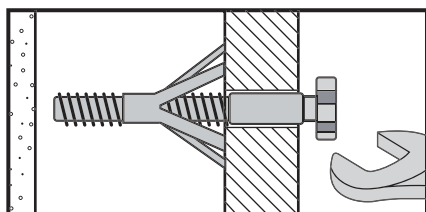

4. Cavity Fixing Heavy Duty Wall Plug

For use when fitting or supporting heavy loads such as shelving and wall cabinets.

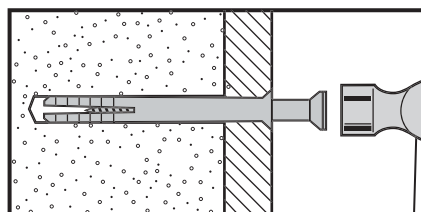

5. Hammer Fixing Wall Plug

For use with concrete block or brick walls, or walls stuck with plasterboard. The hammer fixing allows it to be fixed to the wall rather than the plasterboard. Always check the fixing is secure to the retaining wall.

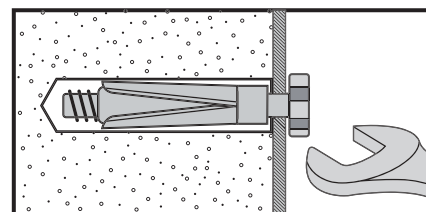

6. Shield Anchor Wall Plug Heavy Loads

For use with concrete or brick walls, or for use with heavier loads such as TV & HiFi speakers and satellite dishes, etc.

SIMPLY 6 CUBE SHELVING

Item Code: 428457

Assembly Instructions

SPECIAL TIPS FOR FITTING CAM-LOCKS AND QUICKFIT

CAM-LOCK

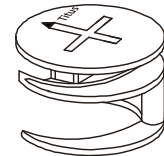

WHEN FITTING CAMLOCK
ENSURE STARTING POSITION IS CORRECT
BEFORE YOU INSERT CONNECTING QUICKFIT
TURN CLOCKWISE UNTIL SECURE

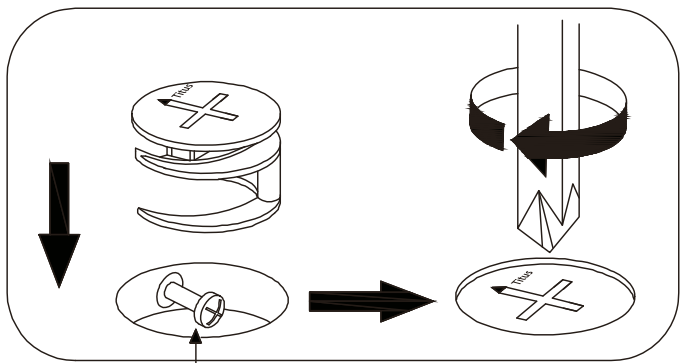
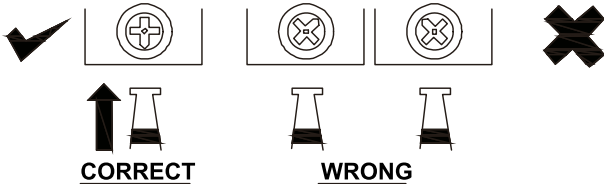

Quickfit head needs to be in centre

QUICKFIT

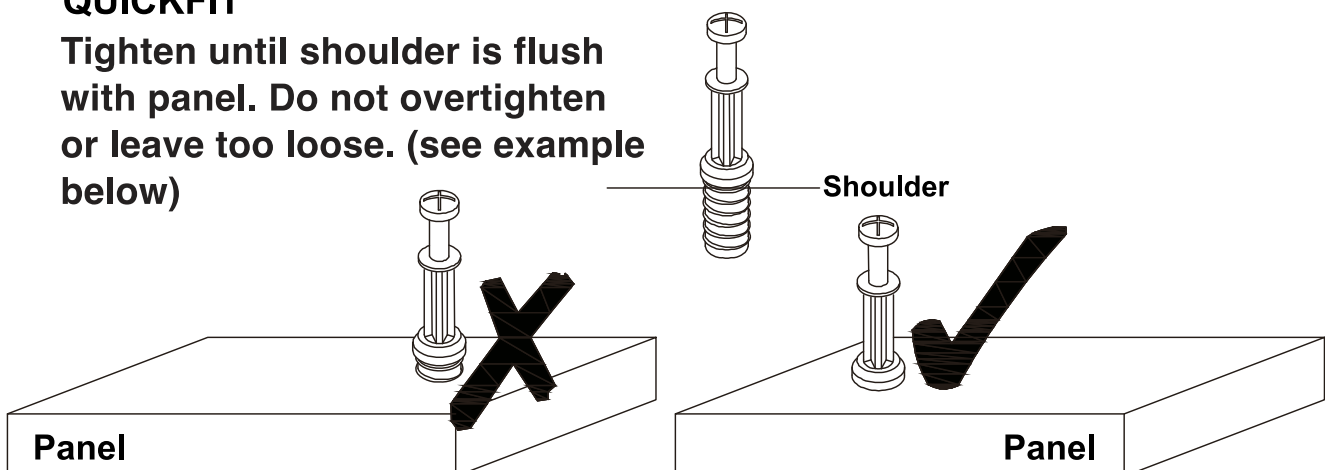

Tighten until shoulder is flush with panel. Do not overtighten or leave too loose. (see example below)



SIMPLY 6 CUBE SHELVING

Item Code: 428457
Assembly Instructions

STEP 1

| | | |
|----|---|------|
| P7 |  | 4pcs |
| P8 |  | 4pcs |

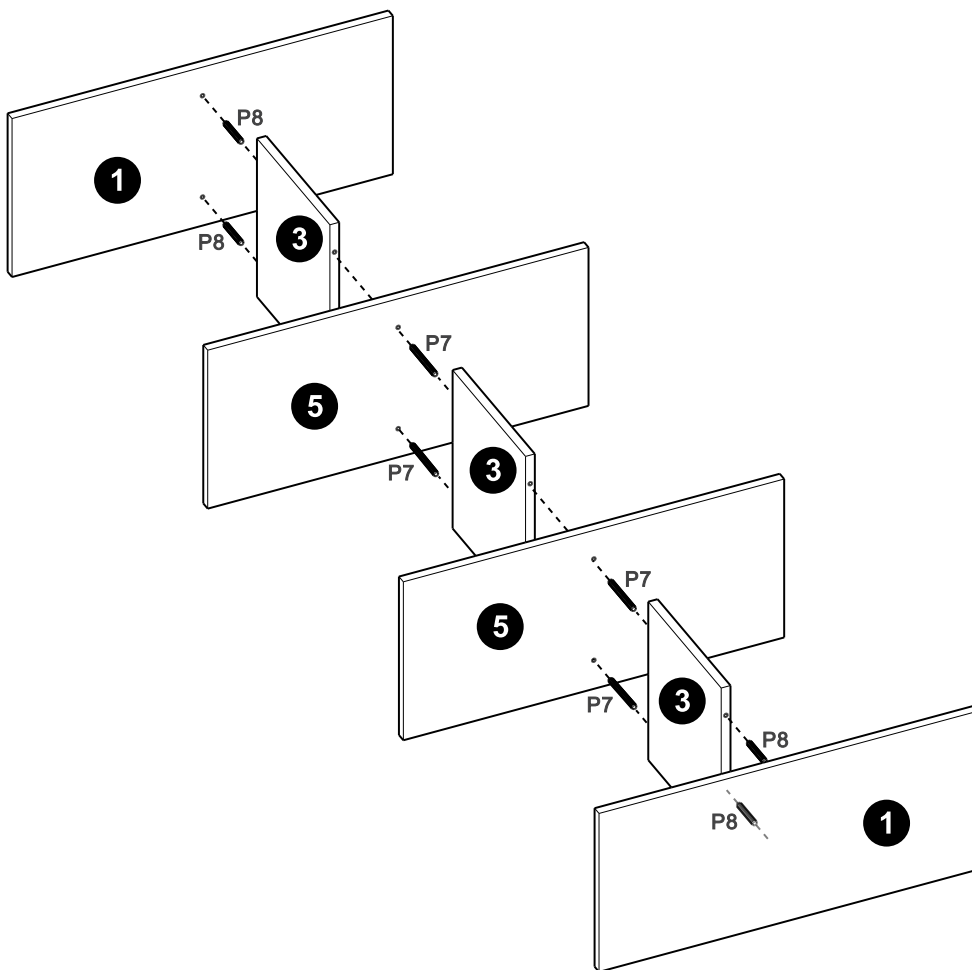

SIMPLY 6 CUBE SHELVING

Item Code: 428457

Assembly Instructions

P1



16pcs

STEP 2

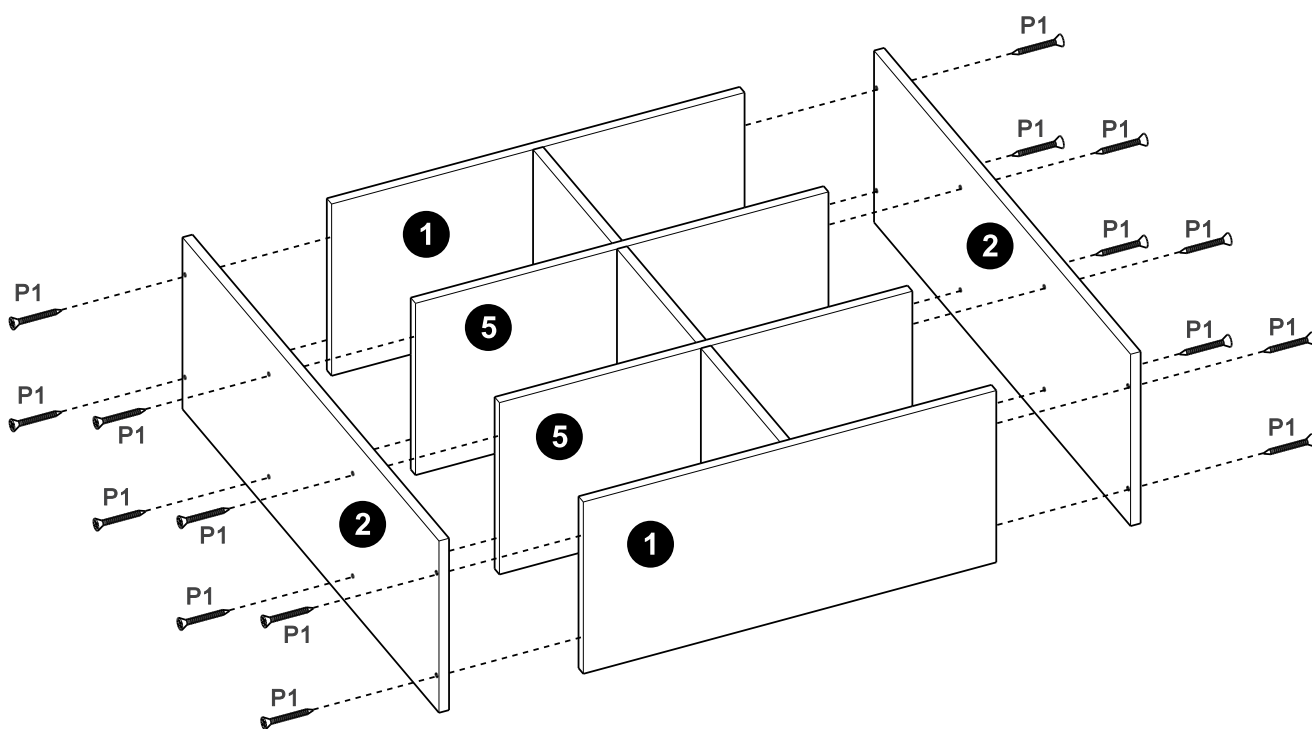

SIMPLY 6 CUBE SHELVING

Item Code: 428457
 Assembly Instructions

STEP 3



| | | |
|-----|--|-------|
| P2 | | 24pcs |
| P10 | | 4pcs |

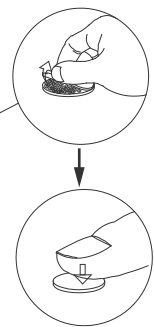
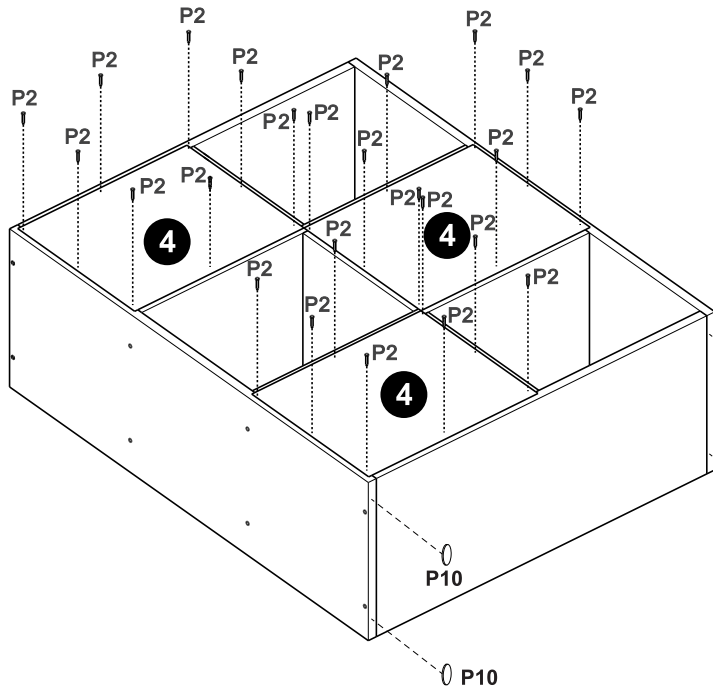

STEP 4

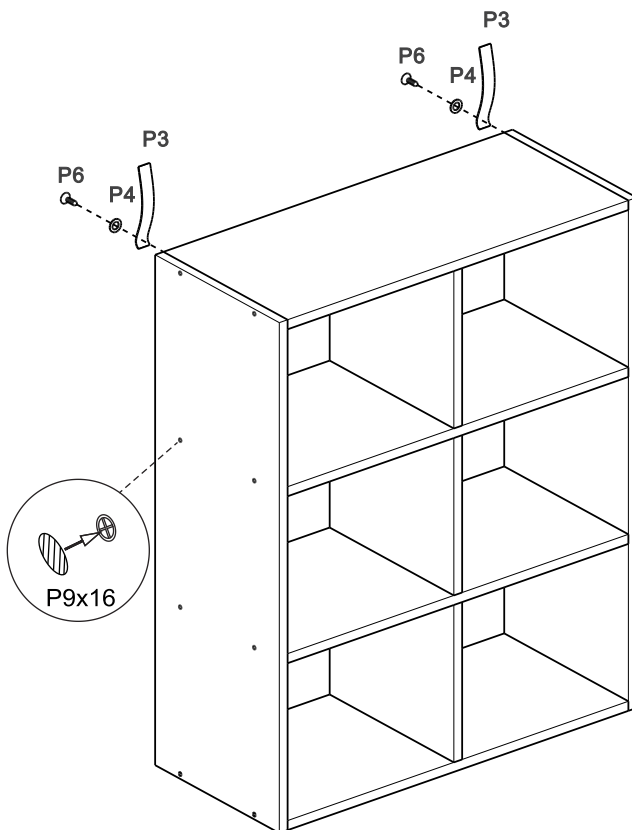



| | | |
|----|--|-------|
| P3 | | 2pcs |
| P4 | | 2pcs |
| P6 | | 2pcs |
| P9 | | 16pcs |

SIMPLY 6 CUBE SHELVING

Item Code: 428457

Assembly Instructions

STEP 5

| | | |
|----|---|------|
| P1 |  | 2pcs |
| P4 |  | 2pcs |
| P5 |  | 2pcs |

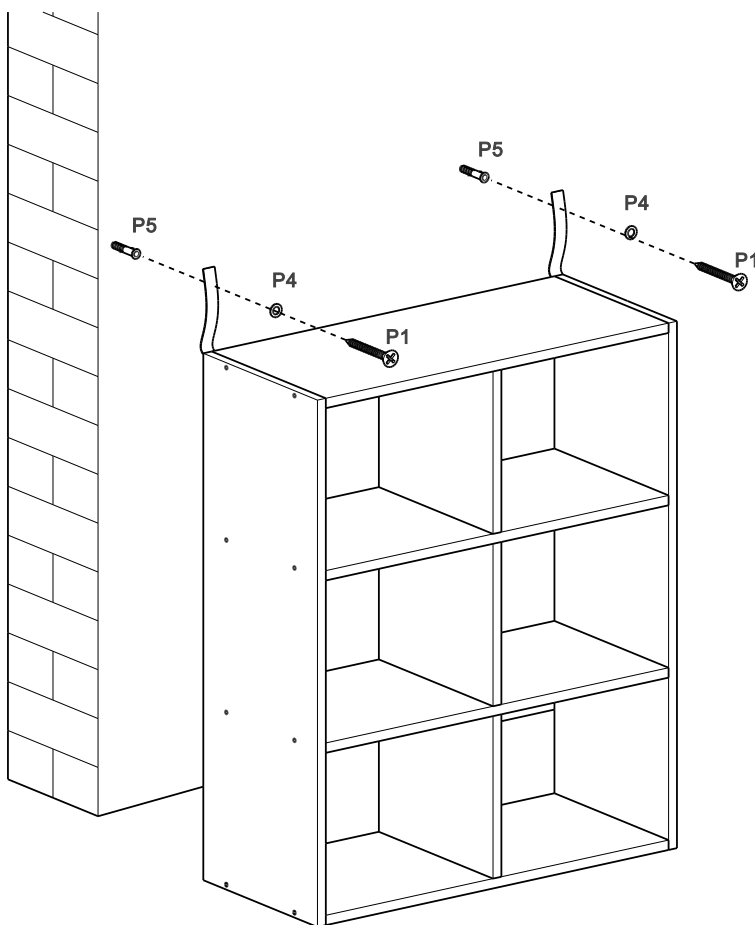
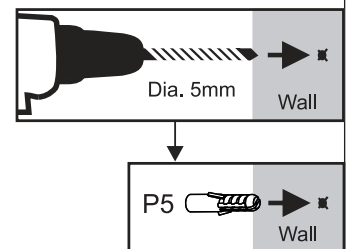

WARNING: Anti-tipping hardware is only a deterrent. It is not a substitute for proper adult supervision.

Young children may be injured by tipping furniture and the use of a tipping restraint is highly recommended.

This hardware, when properly installed, could provide protection against the unexpected tipping of furniture due to improper use.

Please ensure the anti-tipping hardware provided is suitable for your wall or else, it might damage your wall during installation.



B&M Retail, L24 8RJ, UK
www.bmstores.co.uk

B&M France SAS, 8 Rue du Bois Joli, 63800, France
MADE IN CHINA

Domestic use only